

L O N D O N W A L L

Type 80



London Wall Type 80 system is a top hung movable acoustic wall of lighter construction made up of individual panels designed to give economical but strong and long lasting use in the division of space requiring flexibility and offers good levels of sound reduction and high quality finish.

Overview

Type 80 is ideal for use in meeting rooms, classrooms, church halls and offices. Panels can be finished in priming sheet for client decoration, standard factory finish in standard laminate or spray paint, textile coverings, full range of veneers and laminates or to suit clients requirements.

- Top-hung, individual panels
- Manual operation
- Sound reduction up to Rw 53dB
- Aluminium frame

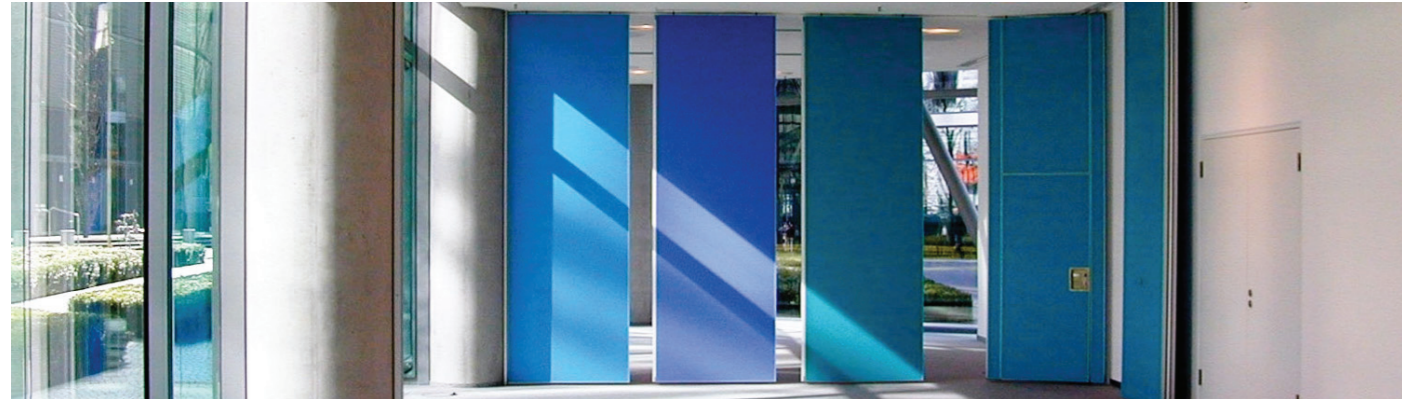
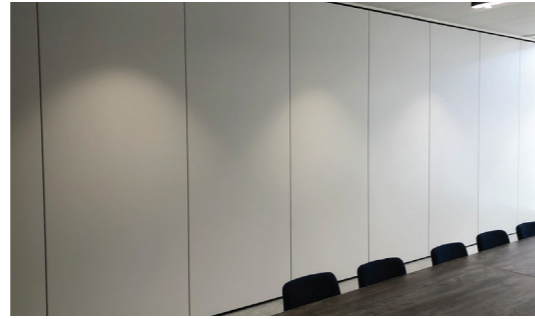

Features

Height: Up to 6,000mm
Panel Width: Upto 1,250mm (wider on request)
Sound Reduction: Up to Rw 53dB
Panel Thickness: 80mm
Suspension method: Top hung, no floor track
Operation Mode: Manual
Panel Type: Individual panel
Seal Type: Retractable
Panel Construction: Aluminium frame
Panel Weight: Up to 56kg/m²
Fireproof Qualities: Class 1, Class 0, F30, F60
Pass Door Panels: Full Height, Single Inset
Usage: Internal
Panel Edges: Exposed or concealed, SAA or powder coated
Panel Finishes: Laminate, HP Laminate, Veneer, Fabric, Steel, Whiteboard, Magnetic whiteboard
Other Options: Curved, Glazed cut outs

Stacking Options: TL1 ('E' system), TL2 ('Za' system)
TL3 ('Zb' system), TL4 ('Z' system), TL5 ('K' system)
TL6 ('K' system), TL7 ('K' system), TL8 ('K' system)



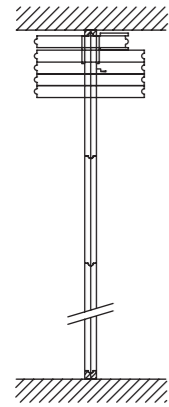

TL1 ('E' System)

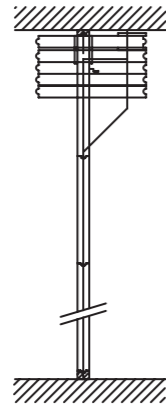

TL2 ('Za' System)

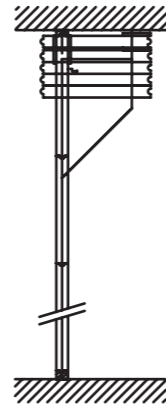

TL3 ('Zb' System)

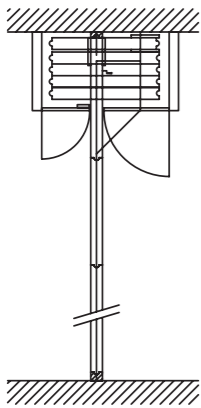

TL4 ('Z' System)

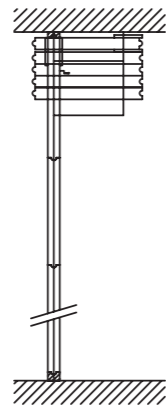

TL5 ('K' System)

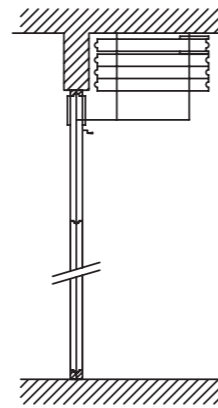

TL6 ('K' System)
Panels stacked behind reveal.

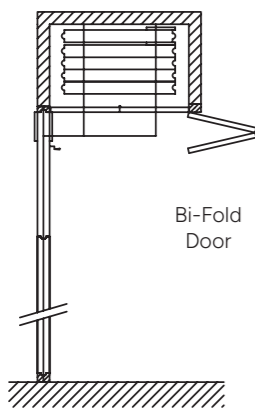

TL7 ('K' System)

Panels stacked inside wall recess.

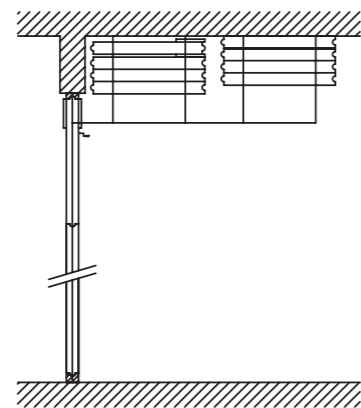

TL8 ('K' System)

Panels stacked in branches to one or both sides.

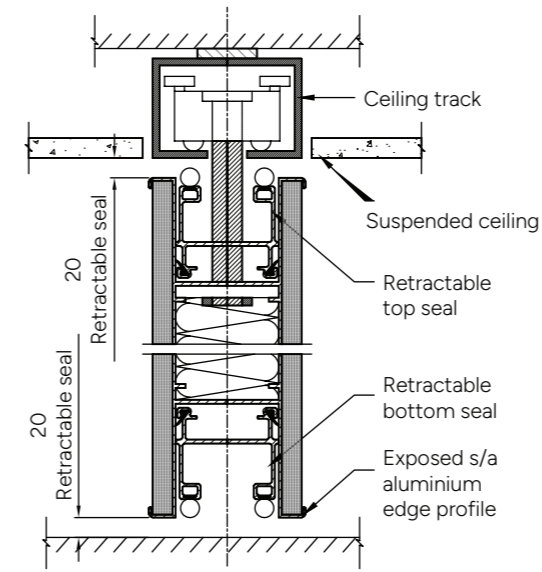

Vertical Section Through Standard Panel

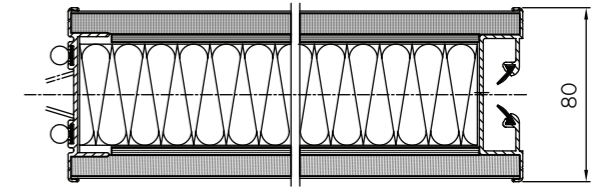

Horizontal Section Through Standard Panel (NE) - Exposed edge profile

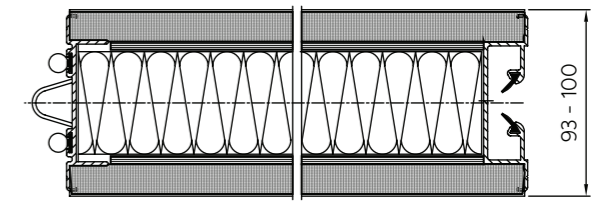

Horizontal Section Through Standard Panel (NE) - Concealed edge profile

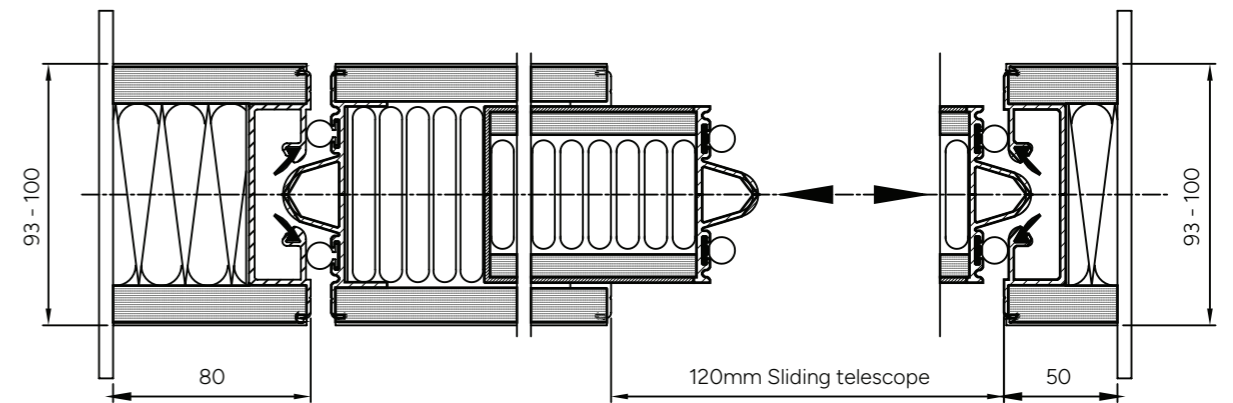

Horizontal Section Through Telescopic Panel & Wall Jambs



LONDONWALL

www.londonwall.co.uk
info@londonwall.co.uk
020 8391 8750

London Wall Design Ltd
63 Barwell Business Park
Chessington
KT9 2NY